

User Manual
STUDIOART

A100 Active Room Speaker
P100 Passive Room Speaker

Introduction	1
Unpacking	1
Network Requirements A100.....	1
Scope of delivery	1
Optional Accessories	1
A100/ P100 Device view	2
Notes on the built-in rechargeable battery of the A100.....	2
Mains Supply Jack [15 VDC IN]	3
LAN connection [LAN]	3
Reset button [Micro opening].....	3
Analog input [Aux-IN].....	3
External loudspeaker [■ P100].....	3
USB Service Port [USB].....	3
Charging the battery	4
Switching the A100 on	4
Switch source	4
Adjust volume	4
Shut down A100.....	4
Put the A100 into standby	4
A100 Legend LED display	5
Status / Sources LED display	5
Akku / Start LED-Anzeigen	5
Presets-Anzeige.....	5
Commissioning	6
Speaker placement.....	6
Wall mounting.....	6
Care.....	6
1. Integration of an A100 into the domestic network via Wi-Fi / LAN.....	7
Integrating the A100 in the local network using WPS * function	7
Integrating A100 in the local network using an Apple device	8
Integrating A100 into the local network using an Android device.....	8
Integrate A100 into the local network via a LAN connection	9
Assigning a manual IP address.....	10
Connecting an A100 to other STUDIOART products via cable or wireless	11
A) STUDIOART A100 with P100 cable connection	11
B) Connecting STUDIOART A100 to further A100 - Wireless connection	11
Wireless connection: Without the STUDIOART app, proceed as follows:	12
Wireless connection: With the STUDIOART app proceed as follows:	12
Connecting STUDIOART A100 to B100 Bass Module	13
Without the STUDIOART app proceed as follows:	13
Proceed as follows with the STUDIOART app:	13
The Basic Features of the STUDIOART App	14
Configuation	14
Audio setup	14
Info-Setup	15
Pairing Setup	16
Connect / disconnect speakers 	17
Configuration of paired speakers.....	18

Operation STUDIOART App	19
Speaker / room selection	19
Source and music selection.....	19
Source and music selection.....	19
List selection.....	20
Play view	20
FAQ	21
1. The A100 is not shown in the STUDIOART app	21
2. The STUDIOART app indicates that the mobile Android device no longer has a network connection.....	22
3. Connected STUDIOART products lose their paired status or the audio is interrupted.....	22
4. The A100 Room Speaker can no longer be started or switches itself off.	22
5. Automatic switch-on from local input <i>Analog IN</i> is not triggered	22
6. The A100 is not listed as a playback device on my Bluetooth®-enabled device/mobile phone	22
7. When playing an album, music playback stops at the end of a title.....	23
Technical Data A100	24

Introduction

Congratulations on your purchase of the new STUDIOART Room Speaker and thank you for your trust in our high quality products.

To enjoy excellent sound quality in your home, carefully read the following instructions *before* first-time operation.

General safety instructions, disposal of your old device and warranty conditions can be found in the enclosed leaflet.

Take note of the labels on the device or its external power supply:



To avoid the risk of electric shock, do not remove any covers. Maintenance and repair may only be carried out by qualified specialist personnel!

Unpacking

We recommend that you keep the packaging material in case you should need it to transport the speakers in the future. Please check the **STUDIOART** loudspeaker and accessories after unpacking for completeness and transport damage. Before putting the device into operation, please read the operating instructions carefully. Keep it as a reference book.

A device which shows mechanical damage or which liquid has entered must not be connected to the mains.

To avoid the risk of electric shock, do not remove any covers. Maintenance and repair may only be carried out by qualified specialist personnel!

Network Requirements A100

The STUDIOART system communicates over a 2.4 GHz or 5.0 GHz home network that supports 802.11 b / g / n wireless technology. Addresses in the network are automatically assigned via DHCP. A manual IP configuration can be carried out via the web interface using a browser. You can find more about this in Chapter 1 "Integration into the home network".

The **STUDIOART** app is available at no cost for Android devices with Android 7.0 or higher and Apple devices with iOS 9.35 or later.

Scope of delivery

- STUDIOART A100 Room Speaker (1x)
- Power Supply 15VDC / 4A with Power Cord (1x)
- Leaflet *Safety Instructions & Warranty* (1x)
- Quick Start Guide **STUDIOART**
- Welcome Letter
- Warranty Card
- Product Information **STUDIOART**

Described software version: V3946.0 - V3 - **V37** (see ⓘ)

Optional Accessories

- **STUDIOART** Wall bracket kit (for 1 pair of A100/ P100 or A100/ A100) (Art.no.: 1.410.201.01)
- **STUDIOART** Carrying case black for A100/ P100 [1.410.201.02]
- **STUDIOART** Floor stand for A100/ P100 [1.410.900.01 black foot - 1.410.900.02 silver foot]
- **STUDIOART** P100 Passive Room Speaker black / white

With the STUDIOART P100, the active A100 can be expanded to a stereo pair. It is purely passive and powered by the power amp of an A100. The connection is made using a speaker cable supplied with the P100.

A100/ P100 Device view

Room Speakers

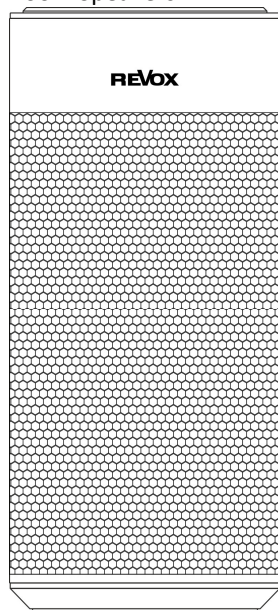

A100/ P100 Front view

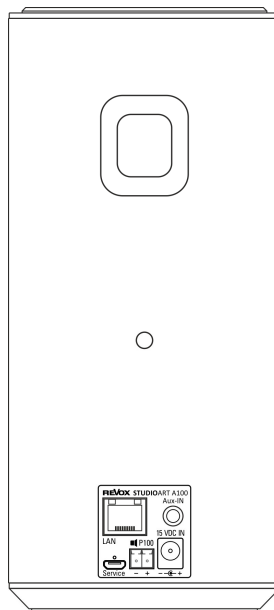

Rear view A100 with connector panel

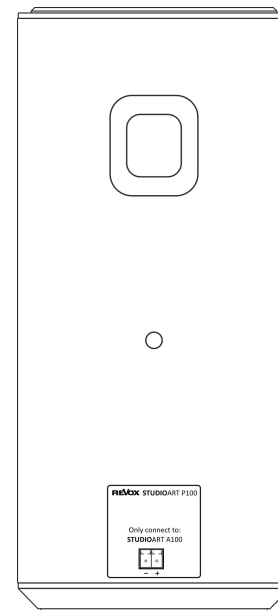

Rear view P100 with connector panel

Notes on the built-in rechargeable battery of the A100

- All Revox rechargeable batteries are delivered to retailers / end customers at the factory with a charge level of 30%. Before using the battery for the first time, it should be charged to 80-100%.
 - Our batteries can be charged without hesitation in a range of +5 to +40 degrees Celsius battery temperature.
 - Every single cell built into a battery is monitored by a battery management system. An integrated sensor measures the temperature at the warmest point inside the battery - if the temperature is too high, the charging process is interrupted.
 - The battery and charger are constantly exchanging data: once a charge level of around 80% is reached, the charger automatically continues to charge with a very low and gentle charging current. When the battery is charged, the charger automatically ends the charging process and the electrical circuit is interrupted.
 - The electronics of the lithium-ion batteries automatically put them into a sleep mode if they are not in use for a longer period of time. This protects against harmful deep discharge. Continuous operation with a battery level of 40 to 80% is optimal.
1. **How long does a battery last, when is a replacement needed?**
That still depends a lot on how and how often the battery is used. With average use, our batteries can still have approx. 80% of their capacity after 2 years. Our batteries usually achieve 1000 charging cycles with 80% remaining capacity.
 2. **Which factors influence the service life?**
A lithium-ion battery increasingly loses its capacity with age. In addition, the number of charging cycles affects performance. There is a membrane in the battery, which is worn out by charging and discharging. Likewise, the electrodes are worn out by chemical processes.
 3. **What is a charge cycle?**
A charging cycle describes the charging from 0 to 100%. Charging from 80% to 100% is therefore NOT a complete charging cycle. Charging twice from 50% to 100% is again a charging cycle.
 4. **How can I increase the shelf life?**
For longer, stationary use, our battery is "recharged" once a week. A battery is a wearing part, it lives from its use. It does not harm it if it is properly discharged at least once a month.
 5. **What harms the battery?**
Many harmful factors are avoided by the battery electronics, including deep discharge, overcharging or excessively high temperatures during charging / discharging. The protective circuit intervenes in these situations. You should avoid storage in very warm places (e.g. car in summer).

Connection panel A100

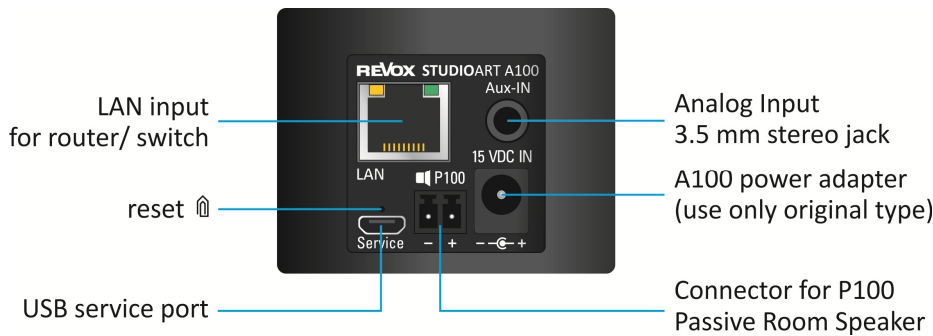

Mains Supply Jack [15 VDC IN]

The A100 uses a low voltage of 15 V DC for its operation. The A100 is designed for permanent use with a connected external power supply. The input voltage of this power supply may be between 100 and 240 VAC. Use only the supplied original power adapter. Other manufacturer's power supplies can damage the A100. In this case, Revox disclaims any warranty.

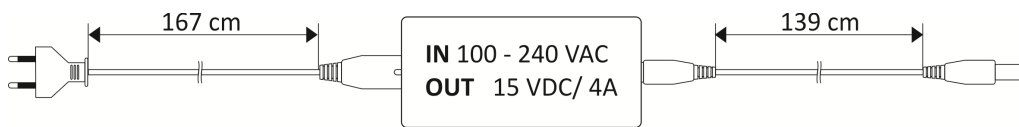

LAN connection [LAN]

If it is not possible to operate the A100 in a stable WLAN, the A100 can also be connected to a router or switch with a patch cable. For reasons of stability, however, it is advisable to either operate all speakers in WLAN or LAN.

Reset button [Micro opening]

If the A100 can no longer be controlled and does not accept commands via the user interface (glass touch panel) or via the **STUDIOART** app, a reset can be carried out using a straightened paper clip or similar object. The main processor is rebooted and a reboot is performed. The A100-specific settings such as Wi-Fi key or the audio configuration are retained.

Analog input [Aux-IN]

External devices can be played back via the A100 via the local analog input. This can e.g. be a CD player, TV or a Smartphone. For mobile devices with low output levels, there is a special setting in the **STUDIOART** app: **Aux-In High Sensivity**. A detailed description can be found in the chapter **STUDIOART** App of this manual. The analogue input is equipped with signal recognition, which automatically turns on the A100 as soon as a music signal is present.

Note:

The automatic switch-on is level dependent, i.e. at very low signal levels, it may happen that the A100 is not turned on or turned off too early. If necessary, increase the input signal while reducing the volume.

External loudspeaker [P100]

Connection to the passive loudspeaker P100 from the **STUDIOART** series. Other speakers must not be connected!

USB Service Port [USB]

This port is designed for factory-internal control and programming processes only.

A100 Touch user interface

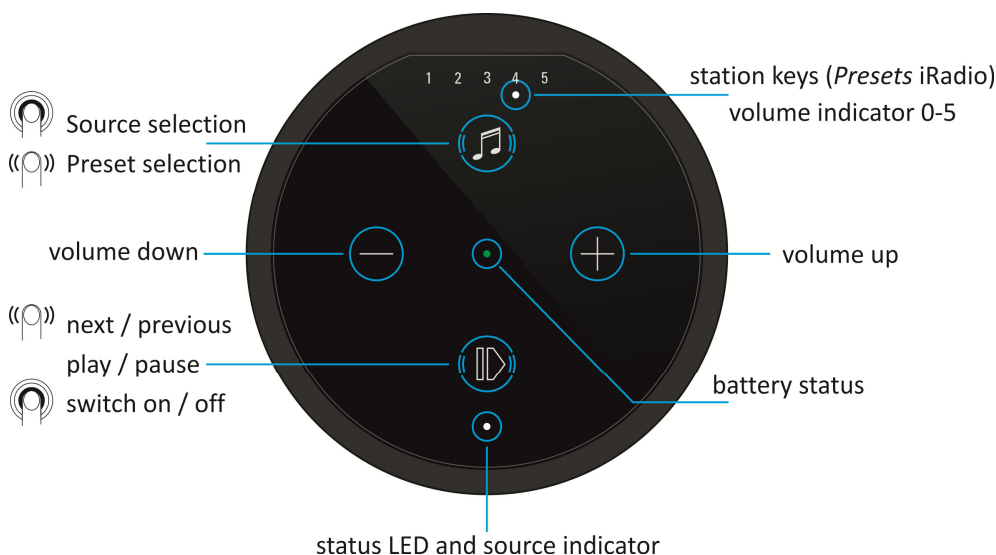

Charging the battery

Please charge the A100 Room Speaker with the **enclosed power supply unit**. While the battery is charging, the center LED lights up bright orange. After successful charging this changes to green.

Switching the A100 on

Press and hold the button **⏻** for approx. 2 seconds until the 5 preset LEDs start to flash simultaneously. After approx. **30 seconds**, the A100 is ready for operation and the status LED flashes white if there is no internet connection; otherwise the status LED lights up continuously in the colour of the selected source - see next chapter.

Switch source

Press and hold the key **⏻** until the source LED starts to change colour. Two sources are available locally:

green ● : Local analogue input [3.5 mm jack plug on rear of housing]

blue ● : Bluetooth connection [BT name: Revox A100]

white ● [Preset LED]: Stored Internet radio stations. Not used at new delivery.

Info: If no music is played via the sources, the source LED will flash. Presets 1-5 for Internet radio stations can be set up via the **STUDIOART** app.

Adjust volume

With the two buttons **⊕** and **⊖** you can set the desired volume. During the volume change, the 5 preset LEDs indicate the approximate volume.

Shut down A100

Press and hold the **⏻** (Play / Pause) button for approx. 2 seconds until all LEDs have gone out. The A100 is now completely switched off and can only be switched on again at the A100. The **STUDIOART** app he is not available in this condition.

Put the A100 into standby

Press the button **⏻** briefly (Play / Pause). After a break of more than **25 minutes**, the A100 automatically goes into standby. In this operating state, the app can be accessed at any time on the A100.

A100 Legend LED display

Status / Sources LED display

	Farbe	Intervall	Bedeutung
●	green	permanently	Local analog input plays (Analog IN)
●	green	blinking	Local analog input selected, but music signal not available
●	blue	blinking	Ready for Bluetooth pairing
●	blue	permanently	Bluetooth connection established
●	pink	flashing fast	A100 as client speaker ready for pairing / periodically beep
●	pink	flashing slowly	A100 as main speaker (Chief) ready for pairing / periodically double beep
●	pink	permanently	A100 is connected speaker (client)
●	red	blinking	An update is being installed
●	white	flashing slowly	A100 is in hotspot mode
●	white	blinking	A100 is connected to the network, no streaming source is currently playing
●	white	permanently	A100 plays streaming source (Internet radio, podcasts, Spotify, etc.)
●	white	3x fast/ pause	A100 is in WPS mode and can be paired with WiFi routers

Akku / Start LED-Anzeigen

	Farbe	Intervall	Bedeutung
●	green	permanently	Battery is fully charged - power supply may or may not be removed
●	orange	permanently	Battery is currently being charged
●	red	permanently	Battery has less than 15% charge and should be charging soon

Presets-Anzeige

	Farbe	Anzahl	Bedeutung
○ ○ ○ ● ○	white	1 of 5	A preset is selected
● ● ○ ○ ○	white	From 0 up to 5	Volume display (0-100%) with volume change. Display duration approx. 3 seconds
● ● ● ● ●	white	All 5 blinking	A100 starts from standby - duration approx. 30 seconds

Commissioning

The operating instructions are subdivided into 3 major chapters:

1. The integration of an **A100** into the home network via WLAN / LAN
2. The connection of an **A100** via cable or radio (pairing) with other **STUDIOART** products
3. The basic functions of the **STUDIOART** app incl. multiroom with several **STUDIOART** products

Speaker placement

The **STUDIOART** A100 and P100 speakers are loudspeakers that you can install anywhere. The prerequisite is that a good Wi-Fi coverage or a LAN connection is available at the installation site of the A100. When operating in the bathroom, please be aware that the A100 or P100 is moisture resistant but not waterproof. Therefore, do not bring it near water and do not expose it to rain when it is operated outdoors. Excessive sunlight can also damage the A100 / P100.

If you have decided on a stereo constellation (A100 + A100 or A100 + P100), you will achieve the best audio reproduction if the loudspeakers with your preferred listening position form a triangle with roughly equal sides. In doing so, the speakers should radiate from an acoustically hard, reflective environment into the more heavily damped part of the listening room.

The sound "path" should not be obstructed by objects, i.e. you should be able to see the speakers. "Aligning" the loudspeakers to the listening position can have an acoustically advantageous effect since reflections on the adjacent room walls are thereby reduced.

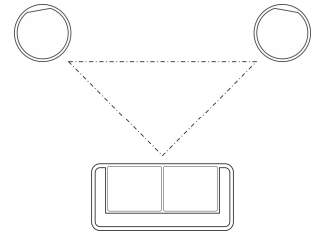

Wall mounting

In case the A100 or P100 is to be fixed to a wall, there is a special **STUDIOART wall bracket kit; Article no. : 141 020 101**. The kit contains two (2x) wall brackets made of high-alloy zinc casting including fixing materials. The wall bracket itself has a horizontal adjustment angle of $\pm 90^\circ$ and a vertical adjustment angle of -16° to $+48^\circ$. Combined with an A100 / P100 on a flat wall, this results in an adjustable beam angle of **horizontal $+6^\circ$ or -45°** and **vertical $\pm 75^\circ$** - see diagram below.

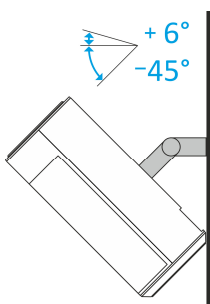
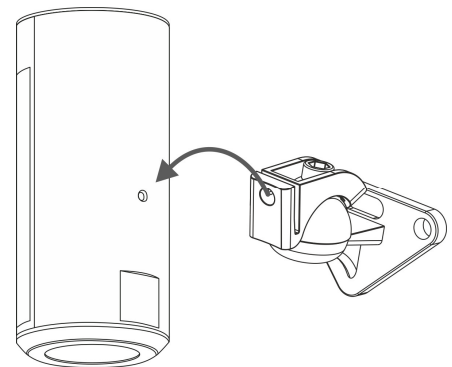

A100 with wall bracket
Orientation up/ down

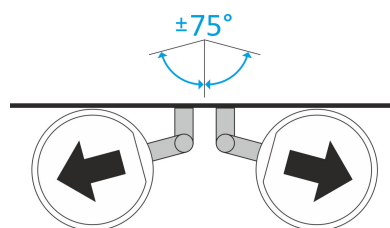

A100 with wall bracket
Orientation left/ right

Care



The real glass surface of the A100 can be cleaned with a mild window cleaning agent. In contrast, the painted housing surfaces should only be cleaned with a damp cloth and then rubbed dry with a soft cloth. Never use cleaning agents with grinding additives.

1. Integration of an A100 into the domestic network via Wi-Fi / LAN

The A100 derives its functionality mainly from streaming content from the Internet. For complete control, the A100 communicates with the **STUDIOART** app, which must also be in the **same network** as the A100. This chapter explains the possibilities of integrating the A100 into the home network.

Important router setting: *Devices are allowed to communicate with each other*

Integrating the A100 in the local network using **WPS** * function

1. Start A100 and bring it into the immediate vicinity of the router.
2. The WPS routine must be completed within 2 minutes.
3. Bring the A100 into WPS mode:  +  hold for approx. 10 sec. until a **double beep** is heard periodically (b). At half this period of time, a simple single beep is first emitted.
 ⓘ Status LED flashes periodically 3 ● ● ● in succession

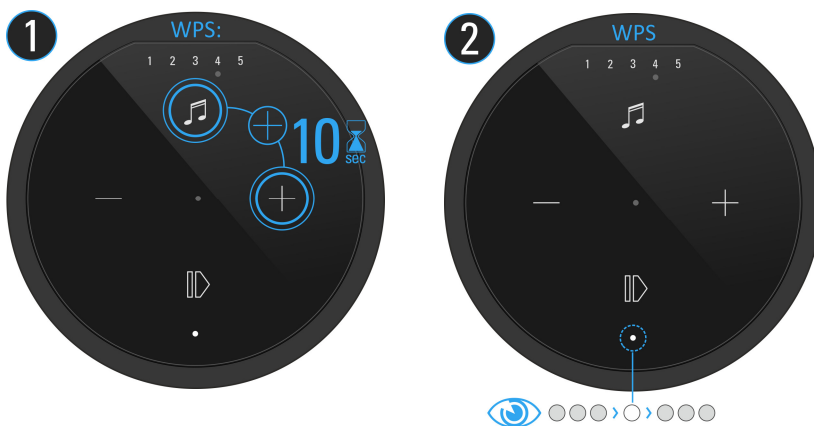

4. Press the WPS button on the router. Some routers also have names such as "Log in" or "Connect"
5. If the A100 has been detected, it is now automatically in the router's Wi-Fi network. It requires no additional input of the wireless key.

Note A100 as rear / paired loudspeaker

Problem:

If an A100 is to be used alternately as a room loudspeaker and rear / paired loudspeaker (from the Audiobar S100 or second loudspeaker A100), we do not recommend a WLAN integration via WPS, as the WLAN password (Key) is sent to the A100 once and in encrypted form. If the A100 is then detached from the home theater or stereo network (KleerNet) and is to work as a single room loudspeaker in the WLAN, it can no longer access the WLAN password and has to be re-integrated.

Solution:

With the integration through AirPlay or the **STUDIOART** app (see next page) the A100 can access the WLAN password again and again. This means that alternating operations can be carried out quickly and easily.

* Automatic connection process of WLAN products. Both devices, router and wireless product must support WPS. For some routers, WPS is disabled at the factory and must first be enabled in the settings.

Integrating A100 in the local network using an **Apple** device

1. Download and install the **STUDIOART** App from the Apple App Store for free.
 Activate S100 hotspot mode: press and hold + for approx. 5 sec (1) until a **beep** is heard periodically (2).
 The status LED flashes slowly , while the A100 sets up its own WLAN (WAC)

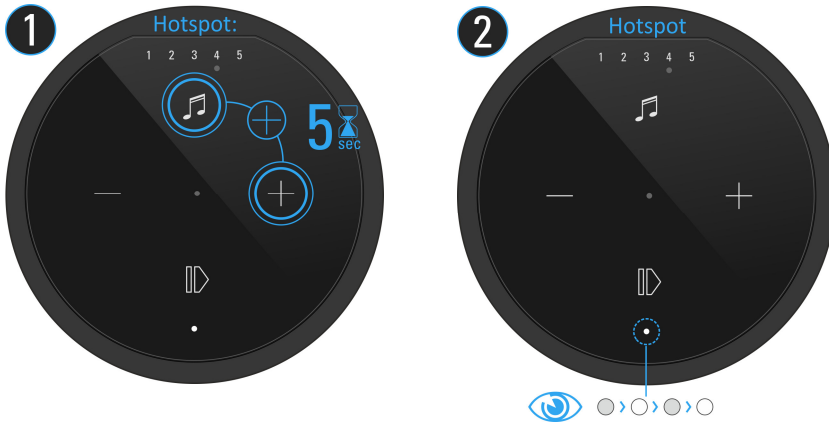

2. Now, in the WiFi settings of the Apple device, select the A100 as a recognised **AirPlay** speaker (not WiFi hotspot) and follow the Apple configuration wizard. The menu "**SET UP NEW AIRPLAY SPEAKER ...**" is show in the iOS WiFi settings in the lower section, **below** the list of detected WiFi networks.

The A100 is displayed as **STUDIOART** loudspeaker in the second line of the app and can be given a new name in the setup.

* AirPlay = AirPlay is a wireless interface which allows iPhones/iPads to exchange music (data) with other AirPlay-certified devices. AirPlay uses the existing home WiFi network for this purpose. AirPlay also works when the S100 Audiobar is connected to the home network via a wired LAN connection. The Audiobar supports AirPlay 1 and AirPlay 2.

Integrating A100 into the local network using an **Android** device

1. Download and install **STUDIOART App** from the Google Play Store for free.
2. Press the text line "This line long ..." in App
3. Follow the 4 steps which the app shows with graphics and text:
 - a) Activate S100 hotspot mode: press and hold + for approx. 5 sec (1) until a **beep** is heard periodically (2).
 The status LED flashes slowly , while the A100 sets up its own WLAN (WAC)

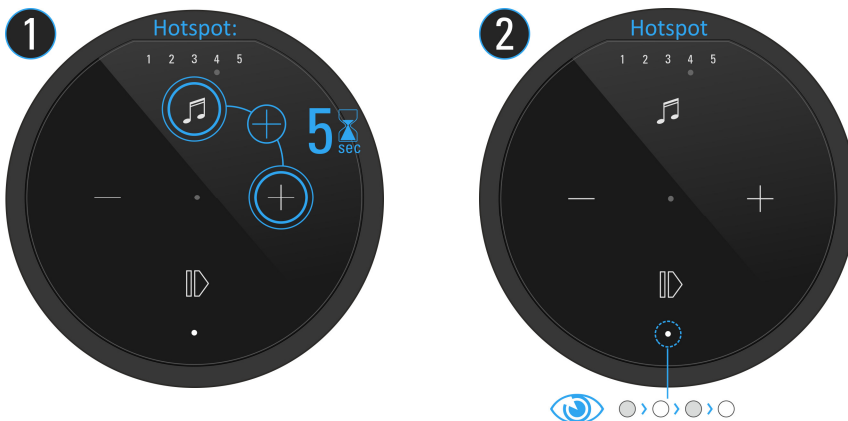

- b) In the WLAN settings, select the A100 (WLAN name: RevoxA100-xxxx)
- c) Select the desired future WLAN network and enter the corresponding WLAN key
- d) In Network settings, select the WLAN in which the A100 is playing

Integrate A100 into the local network via a LAN connection

Should it not be possible to operate the A100 in a stable WLAN, it can also be connected to a router or switch with a LAN cable (patch cable with RJ45 plug).

When binding via LAN, the A100 is connected to the network without further binding routines.

Important note

In multi-room operation, **STUDIOART** loudspeakers can be operated via LAN as well as via WLAN in the home network. For reasons of stability, however, it is advisable to either operate all speakers in WLAN or LAN.

Attention: **Bluetooth** and all local sources that are connected via **cable** with the connection panel of the A100 **cannot** be passed from one **STUDIOART** loudspeaker to another **STUDIOART** loudspeaker.

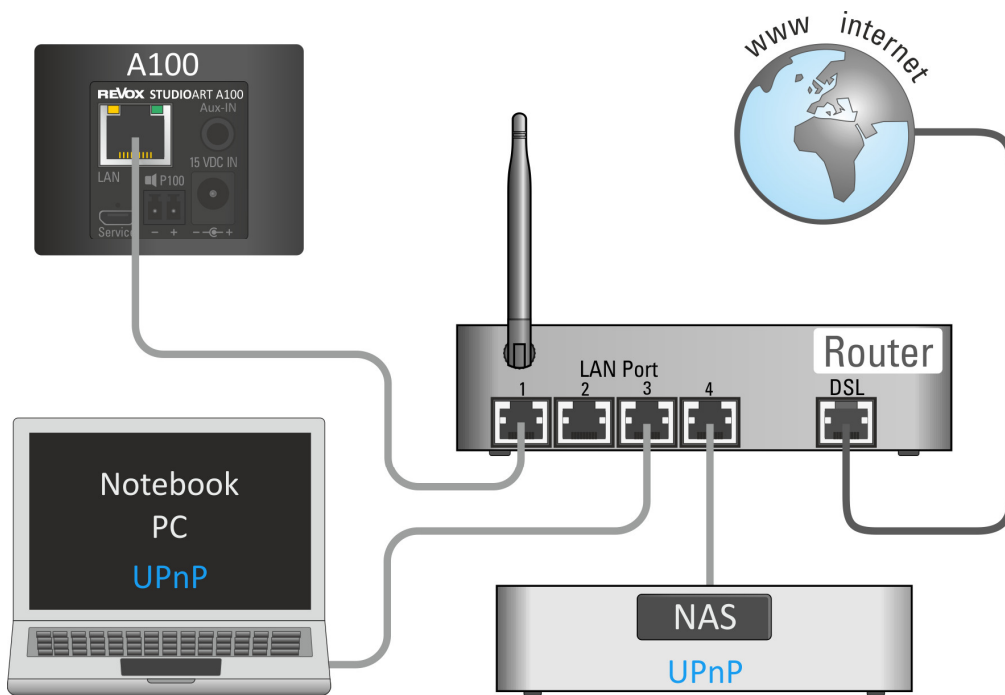

Assigning a manual IP address

The A100 is factory-set for automatic IP address assignment using DHCP. There is also the option of integrating the A100 into the network by manually assigning the access data.

To do this, bring the A100 into your home network for the first time using one of the various WLAN access routines, as described in Chapter 1, or using a LAN cable. You can read out / determine the IP address of the A100 Active speaker using the **STUDIOART** app (➡ Setup / Info) or a network IP scanner. Enter this IP address in the command line of your browser. Immediately afterwards, the Revox web interface opens, in which, in addition to the manual IP address assignment, you will also find change options for the A100 name, WLAN band and a manual update option.

Select Your Network

Enter SSID Manually

Security Security Type ▾

Static IP
ON/OFF

To configure Static IP, Please fill all the fields

IP Address :

Net Mask :

Gateway :

Primary DNS :

Secondary DNS :

Setup your product to join your network of choice. Static IP ON will help to configure with Static IP. Configure Manually will help to configure with Hidden Network

Configure
Manually

Figure: Web interface of the A100 Audiobar in the browser

Connecting an A100 to other STUDIOART products via cable or wireless

A single A100 speaker can control the left and right music channels as mono speakers. In addition, it is possible to connect an A100 with a second loudspeaker as a stereo pair, either wirelessly with another A100 or with a P100 via a cable connection. A STUDIOART P100 is the passive version of an A100 and has the same speaker system but different electronics.

True stereo playback with two separate speakers has the advantage that there is a very spatial representation with clear right-left positioning and the maximum total sound pressure, compared to a single speaker, increased by 3 dB.

A) STUDIOART A100 with P100 cable connection

The A100 has a stereo power amplifier, which allows it to supply another passive loudspeaker, the P100 of the STUDIOART series. Thus, you get the opportunity to operate a full stereo set. The P100 is simply connected to the A100 with the included speaker cable (P100 accessory, 3 m length). When powering up the A100, the P100 is automatically detected and assigned to the right channel. The active A100 forms the left speaker. This right / left assignment must be observed during installation.

The STUDIOART app also gives you the option to search for a later added P100. This is useful if the A100 is used e.g. was taken on the veranda at short notice and later re-connected to the P100.

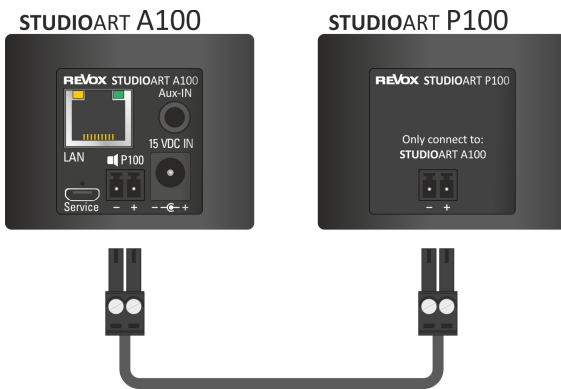

Note: Loudspeaker cable / Correct polarity

If the supplied 3m cable is too short for the required installation variant, the cable can be exchanged for a longer one. The screwable cable clamps are suitable for cross sections up to 1.5m². Care must be taken to avoid a short-circuit due to a wire touching the terminal and that the polarity (+/-) is correct. A polarized speaker emits a diffused sound with little bass. Reverse polarity test: Align the A100 and P100 closely and play bass-heavy music. In case of reverse polarity, the bass is very weak and only becomes stronger again when the speakers are further away from each other.

B) Connecting STUDIOART A100 to further A100 - Wireless connection

When connecting wirelessly, one A100 is defined as the **main loudspeaker (Chief)** and the other A100 Active Room Speaker as the **connected loudspeaker (Client)**. This constellation corresponds to a stereo installation, as the main speaker acts as the left speaker and the connected speaker as the right speaker. Communication takes place with a special wireless-audio solution that works independently **without WLAN**. Due to the **low radio power** of this audio transmission, this type of connection has been developed only for loudspeaker installations **within the same room**.

Distance: For the pairing process, the two A100s should not be more than 2 m apart. In normal operation, the distance may be up to 10 m, provided there are no strong sources of interference such as repeaters, microwave sources, baby monitors, etc. active in the environment.

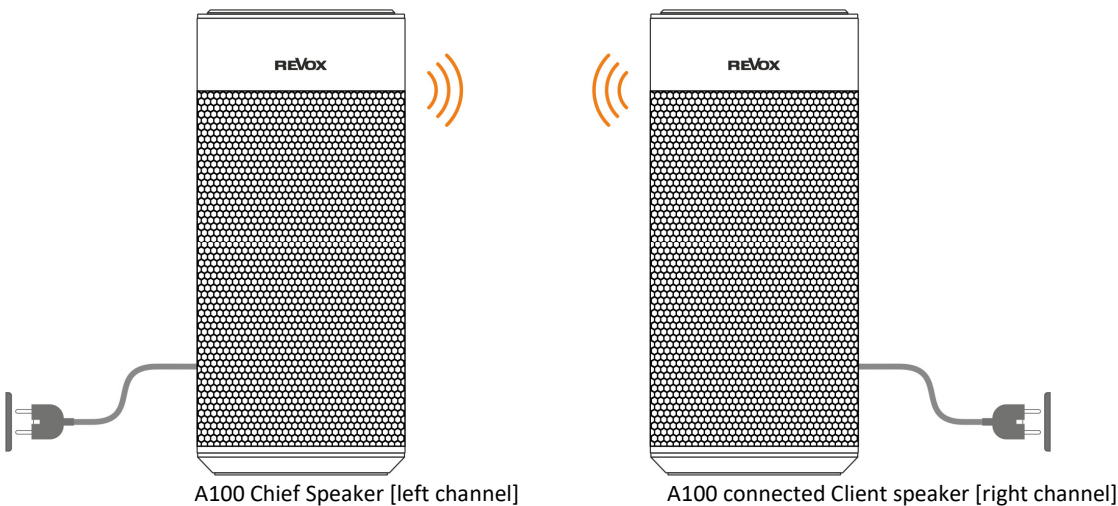

Wireless connection: **Without** the STUDIOART app, proceed as follows:

1. Switch both A100 on by long press of **⏻** - Status LED lights up ●
2. Define first A100 as Chief loudspeaker: **🎵** + **⏻** Hold for more than 8 sec - Status LED flashes quickly first, then slowly ● and a periodic **double beep** can be heard (2)

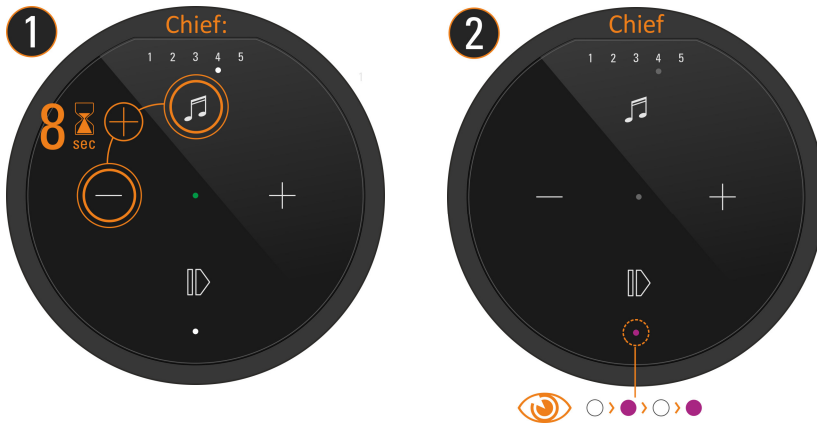

3. Define second A100 as paired loudspeaker (Client): **🎵** + **⏻** hold for approx. 5 sec until a **beep** is heard periodically (4). Status LED flashes quickly ●

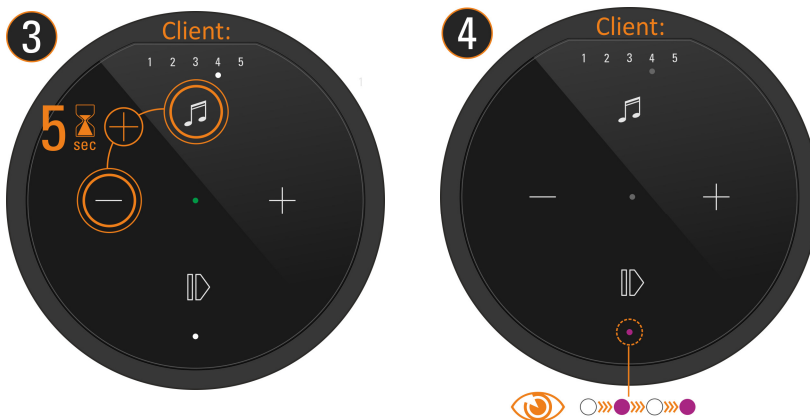

4. Wait until both devices have found each other. Then the A100 LED again shows the source with corresponding LED colour and the status LEDs on the A100 permanently show the pink LED - done.

Now both speakers are paired together. Operation is exclusively on the left Chief loudspeaker. The connected right speaker only appears acoustically and does not provide any operating options.

Wireless connection: **With** the STUDIOART app proceed as follows:

1. Switch both A100 on by long pressure **⏻** - Status LED lights up ●
2. Define first A100 as main loudspeaker:
 - # Call A100 Setup **⚙️**
 - # Select pairing menu **🔗**
 - # Activate with **START** Pairing
 - # Start connection process with **OK**
 - # Perform step 3 within 60 seconds - Status LED flashes slowly ● and a periodic **double beep** can be heard
3. Define second A100 as connected loudspeakers: **🎵** + **⏻** Hold for approx. 5 sec - Status LED flashes quickly ●
4. Wait briefly until both devices have found each other, then the A100 LED again shows the source with corresponding LED colour and the status LEDs on the A100 permanently show the pink LED.
5. End the pairings process with **STOP** - done

Connecting STUDIOART A100 to B100 Bass Module

When pairing, an A100 is defined first, either directly on the device or via the **STUDIOART App**, as the **main speaker**. Then you initiate the pairing process on the B100 Bass Module itself. After successful pairing, the B100 will be listed as a **connected Speaker** in the app and can be further configured there.

Distance: For the pairing process, the A100 and the B100 should be no further than 2 m apart. In normal operation, the distance between A100 and B100 may be up to 10 m, provided there are no strong sources of interference such as repeaters, microwave sources, baby monitors, etc. active in the area. From an acoustic point of view, however, the **distance between A100 and B100 should be kept as small as possible.**



B100 Bass Module: amplifier unit rear view

Without the STUDIOART app proceed as follows:

1. Switch on the A100 by pressing and holding **⏻** - Status LED lights up ●
2. Switch on B100 on the rear panel using the mains switch - Status LED lights up ●
3. Define A100 as chief loudspeaker: **⏻** + **⏻** hold for more than 8 sec - status LED flashes fast first, then slowly ● and a periodic **double beep** can be heard
4. Defining B100 as connected loudspeaker: hold the pairing button **⏻** on the back of the subwoofer for approx. 5 sec - status LED blinks ●
5. Wait until both devices have found each other. Then the A100 LED again shows the source with the corresponding LED color and the status LED on the B100 permanently shows the pink LED - done.

Proceed as follows with the STUDIOART app:

1. Switch on the A100 with a long press **⏻** - Status LED lights up ●
2. Switch on the B100 on the back with the help of the power switch - Status LED lights up ●
3. Define A100 as the chief loudspeaker: # Call A100 Setup **⚙️** # Select pairing menu **⏻** # Activate with **START** pairing # Start connection process with "OK" # Perform step 4 within 60 seconds - Status LED flashes slowly ● and a periodic **double beep** can be heard
4. Defining B100 as connected loudspeakers: Hold the pairing button **⏻** on the back of the subwoofer for approx. 5 sec - Status LED flashes ●
5. Wait until both devices have found each other. Then the A100 LED again shows the source with the corresponding LED colour and the status LEDs on the B100 permanently show the pink LED - done.



The Basic Features of the STUDIOART App

After all STUDIOART speakers have been connected, this chapter shows how to configure and operate them.

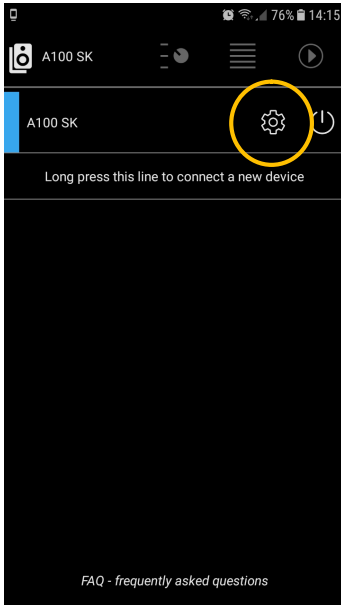
Configuration



The symbol  calls the configuration menu of the individual STUDIOART speakers. The basic settings are subdivided into the following chapters:

- Audio setup 
- Info setup 
- Pairing setup 

Audio setup

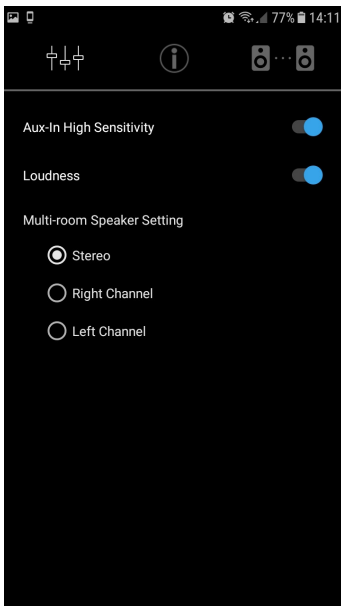

Aux-In High Sensitivity

Third-party devices can be played back via the local analog input **Aux-IN** on the back of the A100. This can be e.g. a CD player, TV or a Smartphone. For devices (mostly mobile) with low output levels, the sensitivity, i.e. the gain, can be increased. With this function activated, the source is played louder.

Loudness

At low volume, our hearing perceives lower frequencies less intensively than medium or higher frequency ranges. This causes people to miss the bass range while listening to music at a low level. Revox has therefore developed a naturally adaptive bass correction, known colloquially as Loudness, which automatically corrects this phenomenon as a function of the volume control.

Multi-room Speaker Setting

If several rooms or A100's are temporarily combined into a multiroom group, which together play a source, this is also called party mode, this setting can be used to determine whether the individual loudspeaker plays both channels (stereo), only the right channel or only the left channel.

Note: This feature should not be confused with a stereo set of A100 speakers that use pairing, one A100 as the main speaker, and a second A100 as the connected speaker. In this constellation, the main loudspeaker automatically plays the left channel and the connected loudspeaker the right channel.

Info-Setup

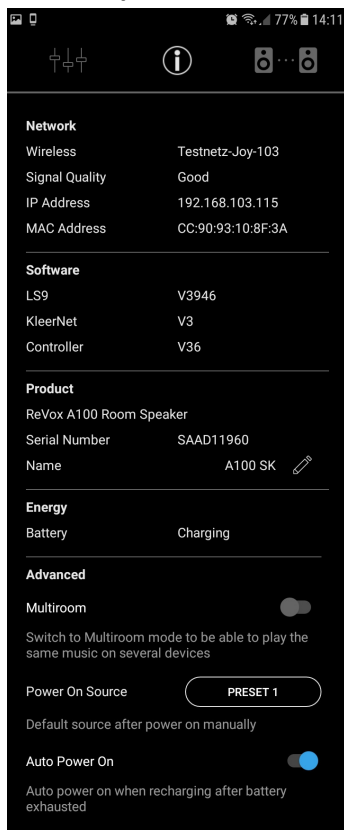

Network

In the network settings, the selected WLAN network (SSID name) and the related IP address are displayed. In addition, the MAC address of the WLAN adapter is displayed out.

Software

This section lists the versions of the following A100 modules:

LS9: Streaming Platform
 Kleernet: Radio Link for Speaker Pairing
 Controller: A100 Main Processor

Product

The exact name of the **STUDIOART** product, its serial number and app name are displayed here. With the help of the pen symbol the name of the A100 can be changed to your own needs.

Energy

Indicates the state of charge of the integrated battery. When the AC adapter is plugged in, the display shows **charging** during charging.

Advanced

Multiroom

If multiple **STUDIOART** products exist which are also operated together as a multi-room group, activate this function. For owners of Apple devices (iPhone, iPad), the multiroom function via **AirPlay2** is recommended, since a multiroom group can also be established here across manufacturers.

Power On Source

This setting allows you to define which source is automatically played back when the A100 starts up after being switched on from a de-energised state or a restart. Available options:

Last heard, Preset station 1-5, Bluetooth, Analogue input.

The selection has no influence over the switching back on of the device from standby using the Play/Pause button. In this case, it is always the last source heard that will be activated.

Auto Power On

This option can be used to determine whether the A100 starts automatically again when it is restarted, i.e. automatically starts playback or remains in standby.

Pairing Setup

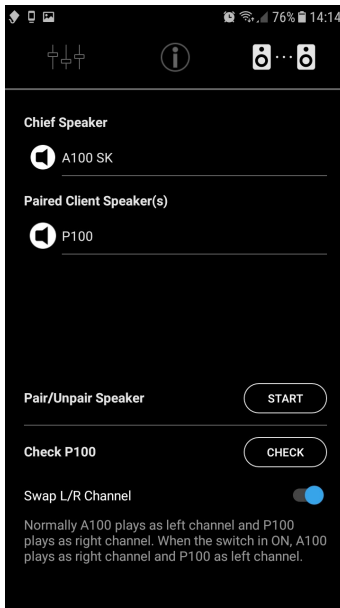

Chief Speaker

Here the main speaker is displayed. If this has been renamed, the name chosen by the user appears.

Paired Client Speaker(s)

The *Paired Client Speaker(s)* section displays all the speakers that are connected either as a passive loudspeaker via cable (here in the example of the P100) or via radio to the main loudspeaker.

Configuration menu

Call the configuration menu of connected speakers e.g. the B100 Bass Module.

Pair / Unpair Speakers

START the pairing routine to add new **STUDIOART** speakers wirelessly or disconnect already connected speakers. This routine is described in more detail on the next page.

Check P100

If a passive P100 **STUDIOART** loudspeaker has only been connected by cable after the A100 has been started, a detection can be started with the **CHECK** key. A detected P100 speaker is listed under **Paired Client Speaker(s)**.

Swap L + R channels

Usually the A100 will play as the left channel and the P100 as the right channel. When the switch is activated, the channels are swapped, i.e. the A100 reproduces the right channel and the P100 the left channel.

Connect / disconnect speakers Start

Distance: The speakers should not be more than 2 m apart for the pairing process. In later operation, the distance can be up to 10 m, provided that there are no strong sources of interference such as WLAN repeaters, micro-sources, baby monitors, etc. in the vicinity.

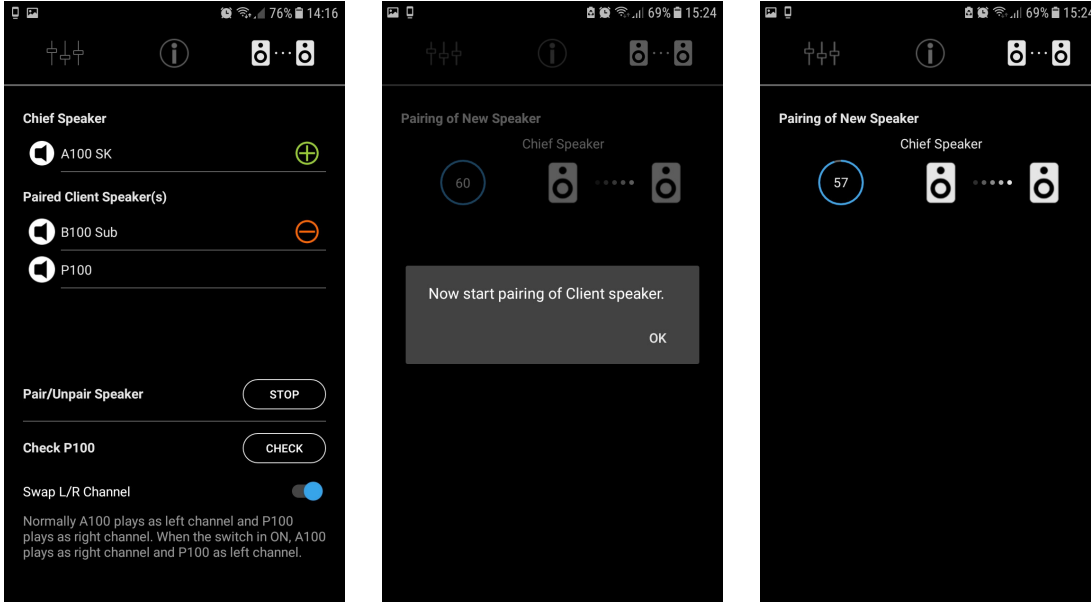

Add

Press the button to start the connection process where the currently selected A100 is acting as the chief speaker. Confirmation “OK” begins the 60-second pairing routine. Within this time another **STUDIOART** A100 or B100 Bass Module has to announce itself as a **client**. The procedure to register a **STUDIOART** loudspeaker as a client is described in the second main chapter of this manual.

Disconnect

The button can be used to disconnect speakers, e.g. a B100 bass module will be disconnected again.

Configuration of paired speakers

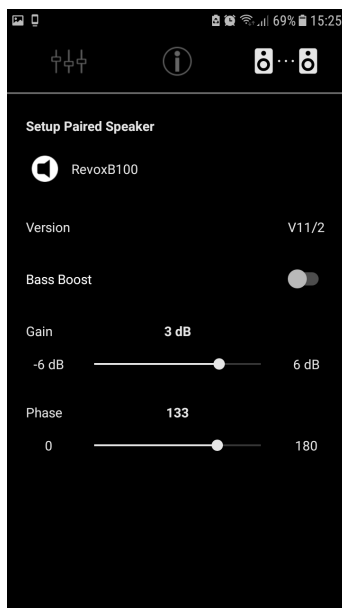

The  icon will bring up the configuration menu of the connected **STUDIOART** speakers. Currently, only the B100 Bass Module has a configuration menu. Here, the following parameters can be set.

Bass Boost

With the Bass Boost, the crossover frequency between A100 and B100 is defined, and depending on this, the maximum achievable sound pressure.

Bass boost disabled

The B100 only supports the A100 below 52 Hz. This is the lowest frequency the A100 can emit. Thus, low-frequency passages are heard and felt. This setting is recommended if the B100 has to be located far from the A100 and the maximum volume is sufficient.

Bass Boost active

The B100 takes over **all** frequencies below 120 Hz. This makes the A100 audibly louder. At the same time, the B100 becomes more locatable, i.e. you can rather determine the location of the B100. From an acoustic point of view, an activated bass boost is more suitable for setup constellations where the distance between A100 to B100 is small.

Note:

When the B100 is wirelessly connected with other **STUDIOART** products, the controls on the rear of the B100 bass module for “volume”, “crossover frequency” and “phase” are disabled. The settings are made exclusively via the **STUDIOART** app - see figure on the left. The controls on the B100 are intended for a wired cinch connection.

The gain and phase setting should be made at the listening position when the placement of the speakers is completed. Only then can the acoustics be correctly assessed.

Gain

With reinforcement, the personal preference for the volume of low frequencies can be determined. The adjustable range is in the range of - 6 dB to + 6 dB. This setting only affects the B100, not the A100.

Phase

The phase adjustment determines how the individually radiated bass waves between A100 and B100 behave towards each other. Depending on the location, the two bass waves at the listening position can add up to a balanced frequency response or even cancel out. For the phase determination, it is recommended to select a song that contains low-frequency bass passages in the range of 40 - 150 Hz. Find the phase setting where the bass sounds most intense. The differences between 0° and 180° are fluid and may be marginal, depending on the type of music chosen.

Operation STUDIOART App

Speaker / room selection

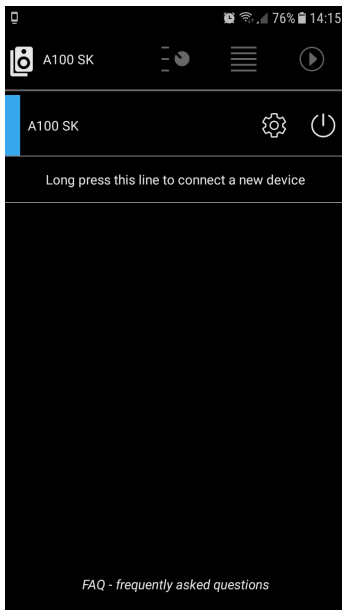

In the **first step**, the **STUDIOART** speaker and/or the corresponding room is selected by tapping on the corresponding row. The currently selected speaker (A100 active speaker) is indicated with a blue rectangle and its name appears in the top left of the row. All speakers that have not been selected are shown in grey. In multi-room mode, which can be activated in the configuration menu of the individual **STUDIOART** speakers, the master speaker is labelled with an **M** (Master) and the participating speaker with an **S** (Servant) in the coloured rectangle.



Pressing the power symbol opens a pop-up menu which offers various standby and shut-off variants – see below.



The gear symbol opens the configuration menu of the individual **STUDIOART** speakers.

Power menu

Power off Switches the Audiobar off. A restart is only possible via the IR remote control or long pressing on the play/pause button on the top side of the Audiobar

Restart Performs a restart of the Audiobar.

Standby Places the Audiobar in standby mode, either immediately or after 15, 30, 45 or 60 minutes. When in standby, the Audiobar can also be switched back on using the **STUDIOART** App.

Source and music selection

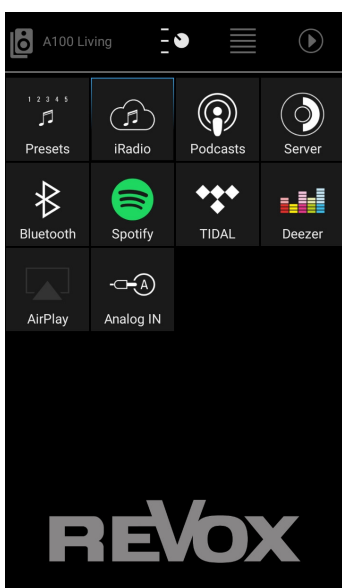

In the **second step** you select the desired source via the switch symbol. The selected source is highlighted in blue, in the example on the left the source iRadio.



Calling up the 5 Internet radio stations stored locally on the A100. The assignment of the 5 preset stations takes place in the iRadio source.



The iRadio source offers over 20,000 Internet radio stations that can be selected using presorted lists or a search function. You can use the character to put preferred stations on one of the 5 preset buttons on the A100.



Podcasts are audio programmes that cover certain topics. Individual programmes can be selected using the search function or pre-sorted lists.



The Server source displays all folders shared in the network that contain music files. The prerequisite is that a UPnP service is installed on the device that makes the music files available. The music formats supported are wav, flac, wma, aac and mp3.



Select Bluetooth to connect to a Bluetooth device, e.g. a Smartphone or tablet. The A100 logs in with the name assigned in the setup. The A100 supports AVRCP, i.e. Pause / Play / Skip is actively supported.



Selects the Spotify music service. You will be redirected to the original Spotify app. This must already be installed on the mobile device. In the Spotify app you select the A100 in "Available devices" using the Spotify Connect icon. The volume function of the A100 is supported in the Spotify app.

Source and music selection

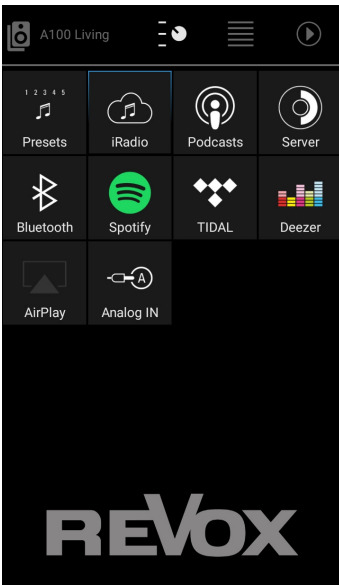

Selects the TIDAL music subscription service. TIDAL is natively integrated into the **STUDIOART** app, i.e. all functions are executed in the **STUDIOART** app.



Selects the Deezer music subscription service. Deezer is natively integrated into the **STUDIOART** app, i.e. all functions are executed in the **STUDIOART** app.



The Airplay icon is an indicator, not an active source. Airplay is selected by an Apple device, which uses the A100 as a playback device. In the **STUDIOART** app (also on Android devices) it only shows whether the A100 is being used as an Airplay source.



Selection of the analogue analogue input **Analog IN**, which is located on the back of the A100. This input is equipped with an input detection, i.e. as soon as a signal is present at the input, the A100 switches to the **analog IN** source

List selection

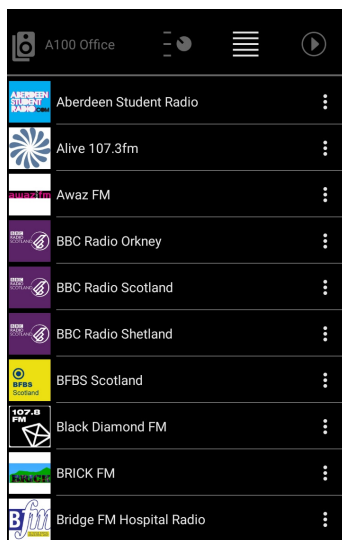

In the **third step** you can select from pre-sorted lists which provide the respective sources or via search functions, the desired title or station. The example on the left shows the list selection of **iRadio** with the category *Popular Stations*.

Note: Special feature iRadio

Here you can also use the 3-point icon on the right to add the corresponding channel to one of the 5 presets, which can then be selected directly via the A100 touch interface **without** using the **STUDIOART** app.

The options in the individual headings are flexible and can change over time. For the sources **Bluetooth** and **Analog IN**, there are no selection lists. Here you are led directly into the playback view, the so-called PlayView.

Play view



The **fourth step** is Playback View. Here the music title or source is displayed with the cover. In addition, the volume can be adjusted in the range of 0-100% via the volume slider at the bottom. The center pause / play button also pauses the playback. After about 20 minutes in "pause" mode, the A100 automatically goes into **standby**. Some sources also offer the **Next** and **Previous** control buttons.

Note: Special feature iRadio

Here you can also use the 3-point icon on the right to add the corresponding channel to one of the 5 presets, which can then be selected directly via the A100 touch interface **without** using the **STUDIOART** app.

FAQ

1. The A100 is not shown in the STUDIOART app

The **STUDIOART** app does not show the A100 in the device list (left main tab with speaker symbol ) , even though a connection was established in the past.

Possible causes:

The A100 is not on the same network as the **STUDIOART** app.

Solution: Check WiFi settings of the mobile device and select the same network as the A100 if necessary.

Possible causes:

The network name (SSID) of the WiFi and/or the WiFi password (WiFi key) which was used to register the A100 on the network was changed.

Solution: Re-register the A100 on the WiFi network by performing the installation steps. Remember to use the new network name and/or password.

Possible causes:

The WiFi communication between the A100 and the **STUDIOART** app has been interrupted/is malfunctioning.

Solution 1: Deactivate WiFi in the settings of the mobile device and re-activate it.

Solution 2: Close the **STUDIOART** app and restart it.

Solution 3: Restart A100 > Press Play/Pause button on the touch interface for more than 2 seconds, wait briefly, then press the Play/Pause button again until the A100 starts up.

Solution 4: Turn repeater off and then on again.

Solution 5: Restart (WiFi) router/access point.

Solution 6: Re-register the A100 on the WiFi network by performing the installation steps again.

Solution 7: In the WiFi settings of the router, the option "Allow WiFi devices to communicate with each other" is not activated in the SECURITY section. Activate/permit this option.

Possible causes:

Third-party devices near the A100 and/or between the router and A100 are interfering with WiFi communications. This may be triggered by these third-party devices operating their own WiFi hardware or due to the use of frequency ranges which are similar to those of the WiFi. The following device categories may impact WiFi communications.

- 2.4 GHz baby monitors
- Wireless video transmitters which utilise the 2.4 GHz or 5 GHz WiFi frequency range
- Wireless audio systems such as Bluetooth which utilise the 2.4 GHz or 5 GHz WiFi frequency range
- Wireless extenders and access points
- 2.4-GHz or DECT wireless telephones
- Microwaves that are switched on
- Set-top box or cable box with wireless technology
- Surveillance cameras with wireless technology
- Direct proximity to other wireless devices (e.g. digital photo frames, garage door openers, mice and keyboards)

Solution 1: Switch off any third-party devices and check whether the malfunction still exists. If the cause of the interference has been found, the distance to these devices should be maximised.

Solution 2: In the WiFi settings of the router, change the channel selection from automatic to a particular channel that is not affected by the wireless interference. There are currently (2021) many sources of interference in the 2.4 GHz range, but less in the 5 GHz range. In the 5 GHz range, only use the channels 48-140, as the audio transfer (KleerNet) between the paired **STUDIOART** products takes place below and above these channels.

*Solution 3: Use a LAN connection instead of a WiFi connection. If no LAN connection is available at the installation site, powerline adapters can be used to establish a LAN connection between the router and the **STUDIOART** product via normal power cables (230 V AC). This wired transmission technology is highly resistant to wireless interference. Popular manufacturers of powerline products are the companies Devolo and TP-Link.*

2. The STUDIOART app indicates that the mobile Android device no longer has a network connection

Possible causes:

The energy saving mode is activated on the mobile device with an Android operating system.

*Solution: Close the **STUDIOART** app and deactivate energy saving mode, then re-launch the **STUDIOART** app.*

3. Connected STUDIOART products lose their paired status or the audio is interrupted

STUDIOART products such as the A100 or the B100 bass module can be connected to each other via the KlearNet wireless system. For such a connection between the A100 and B100 or A100 and A100, interruptions are heard in the audio transmission or the connected speaker (client) is not recognised and/or not automatically switched on together with the *Chief*.

Possible causes:

The frequencies used for the KlearNet pairing in the 5 GHz range on the channels 36-44 and above 140 are also used by the WiFi router.

Solution: In the WiFi settings of the router, change the channel selection from "automatic" to a channel from 48-140.

4. The A100 Room Speaker can no longer be started or switches itself off.

The A100 Room Speaker is no longer visible in the **STUDIOART** app and cannot be switched on via the touch surface or it switches itself off for no apparent reason and can then no longer be switched on again.

Possible causes:

The A100 battery is empty and will not be charged. The central battery LED does not light up, neither orange (battery is charging) nor red (battery low level <15%).

Solution: Check whether the external power supply is connected to the A100. If the battery of the A100 is still not charged when the power supply unit is connected, please also check the power connection / socket.

5. Automatic switch-on from local input *Analog IN* is not triggered

Possible causes:

The level of the line input is too low. This may occur with music that has soft sections.

Solution: If necessary, increase the output signal of the music source while also reducing the volume level on the A100.

6. The A100 is not listed as a playback device on my Bluetooth®-enabled device/mobile phone

Possible causes:

The Bluetooth source is not active or the A100 is in standby mode.

Solution: Ensure that the A100 is switched on and that Bluetooth is active as a source. The source BT will be shown with a blue LED.

Possible causes:

The A100 is already connected to another Bluetooth-enabled device.

Solution: Sever the connection between the A100 and the other Bluetooth-enabled device. Now the A100 can be connected with your Bluetooth-enabled device.

Possible causes:

In the configuration settings, the Audiobar is defined as a Bluetooth transmitter (e.g. for BT earphones) and not as a Bluetooth receiver.

*Solution: In the configuration settings, deactivate the option "**Bluetooth transmitter**"*

7. When playing an album, music playback stops at the end of a title

Possible causes:

The **STUDIOART** app was closed during the playing of the album. It does not matter if it was an album from a music service (e.g. Spotify) or the music server.

*Solution: Do **not** close the **STUDIOART** app when an album is playing. It is sufficient for the app to continue to be active in the background, even if the display is switched off.*

Technical Data A100

Audio data

Loudspeaker principle	Active bass reflex system
Frequency response	52 -30000 Hz

Electrical Data

PowerSupply	
Voltage range	100 -240V AC [50-60 Hz]
Power consumption	max. 60 W
Standby consumption	< 0.3 Watt (Deep standby with network – LED red) < 8 Watt (network active – LED red)

Auto switch-off	25 minutes
-----------------	------------

Dimensions

Height	225 mm
Width	100 mm
Depth	100 mm (without cables) 130 mm (without cables)

Conditions operating

Ambient temperature	+10° ... + 45°C / 50° ... 113° F
Relative humidity	Class F (DIN 40040)

Weight 1,1 kg (without packing)

E&EO

REVOX

Studio Sound Quality

Kontakt/ Contact

www.studioart-revox.com

Deutschland / Germany

Revox Deutschland GmbH

Am Krebsgraben 15, D 78048 VS-Villingen

tel +49 7721 8704 0, fax +49 7721 8704 29

info@revox.de

www.revox.de

Schweiz / Switzerland

Revox (Schweiz) AG

Wehntalerstrasse 190, CH 8105 Regensdorf

tel +41 44 871 66 11, fax +41 44 871 66 19

info@revox.ch

www.revox.ch

Österreich / Austria

Revox Handels GmbH

Josef-Pirchl-Strasse 38, AT 6370 Kitzbühel

tel +43 535 666 299, fax +43 535 666 299 4

info@revox.at

www.revox.at

E&EO

